

Varenummer: 23022246462

Beskrivelse: E+G Vingskrue EWN.55-SST-p-M8x20-PO-C2

Mål

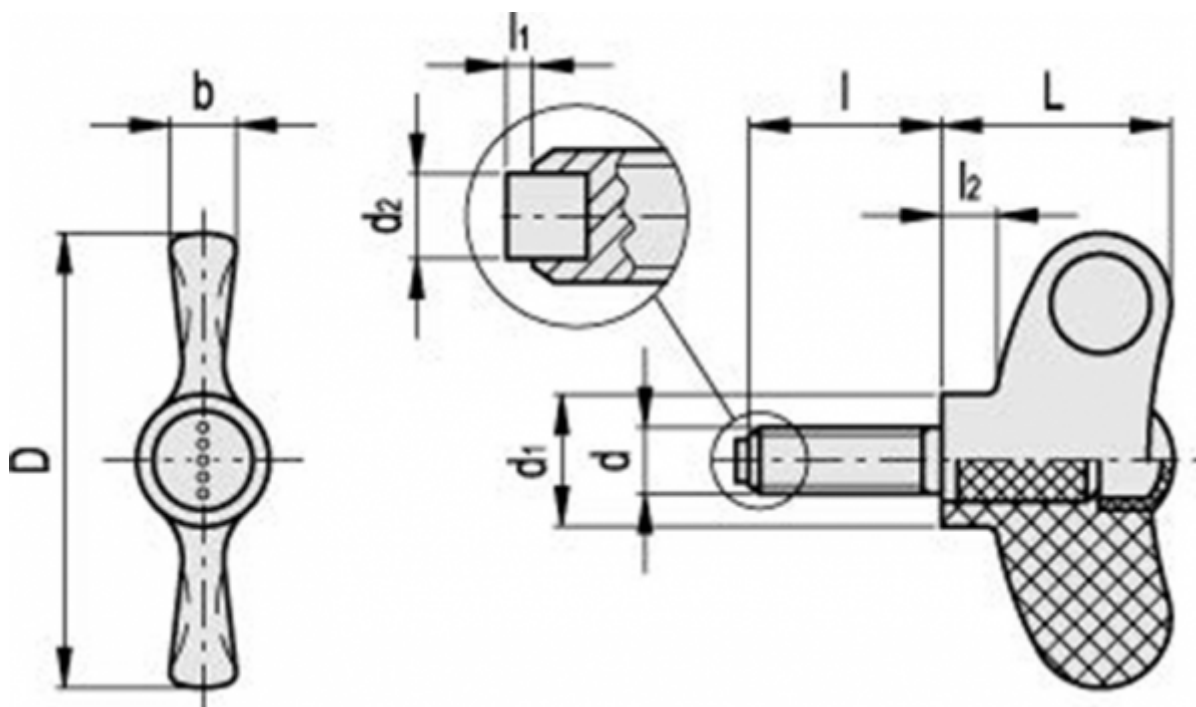

$b = 8$

$D = 55$

$d = 8$

$d_1 = 16$

$l = 20$

$l_1 = 1.8$

$l_2 = 6.5$

$L = 28$

Vægt i (g) = 23